

MBQUART[®]

MUSIC. DEFINED.

Installation Manual



MBQX-STG5-1

**CAN-AM MAVERICK X3
STAGE 5 / 800 WATT / FIVE SPEAKER
UTV-TUNED AUDIO PACKAGE**

Thanks for choosing MB QUART! The UTV-Tuned Stage 5 Audio System for applicable Can-Am Maverick X3 vehicles (2017 and up) has been meticulously engineered for your vehicle. The process is simple and straightforward. Installation following these detailed instructions can be completed in about 3.5 hours.

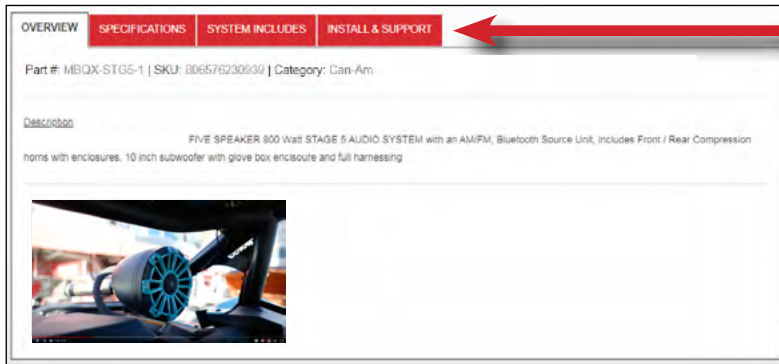

INSTALLATION OVERVIEW VIDEO

Many of our vehicle-specific products feature a “how to” install video with additional details on making your installation successful.

Where available, locate your specific video on the website. Type your model number (MBQX-STG5-1) into the search box, then click on the INSTALL & SUPPORT tab.

WHAT'S INCLUDED

As you unpackage the MBQX-STG5-1 system, account for all components before attempting installation. Please note some components are included that may not apply to your specific model.

What's In The Box?

- AM/FM/WB, Bluetooth, USB Source Unit with Vehicle-Specific Mounting Panel
- Source Unit Wiring Harness
- Compact 2 channel, Class D 400 Watt Amplifier
- Compact Mono, Class D 400 Watt Subwoofer Amplifier
- Dual Amplifier Power and Speaker Harness
- Two RCA Audio Patch Cables
- Dual Amplifier Vehicle-Specific Mounting Plate with Hardware
- Two Dash Panel-Mounted 6.5 inch Coaxial Speakers in Vehicle-Specific Replacement Panels
- Two Roll Cage-Mounted 6.5 inch Coaxial Speakers with Swivel-Mount Brackets
- One Under-Seat Vehicle-Specific 10" Subwoofer with Mounting Brackets and Aluminum Spacers
- Power Harness for (optional) Add-On (Second) Subwoofer Amplifier
- One RCA audio extension cable and two RCA “Y” splitters for (optional) Second Subwoofer Amplifier
- Rear Speaker Extension Harness (intended for 4-Door X3 Models)
- Zip Ties for Securing Audio System Wiring to Vehicle Harnesses

NOTE – Hardware for mounting components to enclosures and other installation-related items you will need are contained within the packaging for each piece. Do not dispose of any packaging until you have completely installed your system and are certain you have accounted for every piece. If you feel something is missing, please contact Maxxsonics directly via email – support@maxxsonics.com.

WARRANTY

Your audio system is covered by a 1 year warranty from the date of invoice. It is important to retain your sales receipt. Furthermore, it is crucial that you record and store a record of the serial numbers for each of the components that are included in your system. In the rare instance that a warranty claim is needed both proof of purchase and serial numbers are required. Additional information on the back page.

TECHNICAL SUPPORT

For additional technical information, go to the “SUPPORT tab at MBQUART.com. There you will find helpful, FAQ, TEQ Tips and you can contact Technical Support via email.

INSTALLATION TIME

About 3.5 hours are required to complete this installation (assuming unmodified vehicle).

TOOLS AND SUPPLIES NEEDED

- Wire Strippers and Crimpers
- Flush Cut Wire Cutters (for trimming zip ties)
- High-Quality Electrical Tape
- Hand-Held Battery-Powered Drill, 9/64" & 1/8" Drill Bits
- Ratchet, 8mm Socket
- 13mm Socket and 13mm Box Wrench (Seat Removal)
- 1/2" Socket (Subwoofer Enclosure Front Brackets)
- T-25 and T-27 Torx Drivers (Dash & Housing Hardware)
- Phillips Screwdriver
- Small, Straight (Jeweler's) Screwdriver
- Heat Gun or Lighter
- Bojo Tools (Non-Marring Pry Tools)
- 10mm Socket (Gauge Cluster/Battery)
- 18mm Socket (Seat Removal)
- 7/16" Socket (Optional 3rd Amp Plate)
- T-30 Torx Driver (Dash/Console)

Depending on which vehicle-specific UTV-tuned audio system you are installing, you may or may not need all of the tools listed above. You may also own more specialized tools to complete the installation. Share the pics of your installation on our social media channels to help others.

In addition to the tools listed, have music ready for INITIAL TESTING and FINE TUNING steps.

- USB thumb drive with music pre-loaded
- Bluetooth device such as a smartphone with music or a music app

SAFETY PRECAUTIONS

Safely prepare your vehicle for the installation before proceeding.

- Turn the ignition off and remove the key
- Use a packing blanket or other soft material to protect your machine
- Safety Glasses - always wear eye protection
- Once all of the seats are removed, disconnect the negative battery cable before proceeding

PREPARATION FOR INSTALLATION & DISASSEMBLY

Before fully dismantling your vehicle, we suggest you prepare all your components, enclosures and wiring harnesses. It increases efficiency to have everything ready when each component is installed. Please note some models with seat belts will require seat belt attachment point removal to remove the whole seat.

REMOVE SEATS - DISCONNECT BATTERY



Slide driver's seat forward and remove two 18mm bolts securing the rear of the seat frame. If the vehicle has factory-installed seats, you can also access these bolts by flipping up the seat cushion (a socket extension is required).

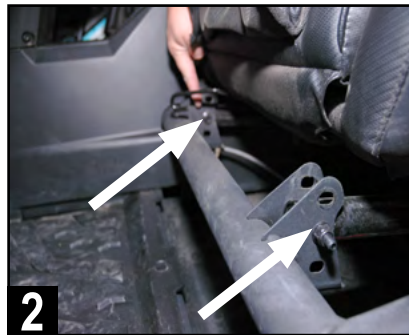

Slide driver's seat back to access front 13mm through-bolts and nuts. Using a socket and box wrench, remove inner and outer front seat hardware. Unplug seat belt sensor. Remove front driver's seat and set aside with all hardware.



Repeat seat removal on front passenger's side (and rear seats - if present). Once passenger seat near battery is removed, disconnect (black) negative battery cable by removing a 10mm bolt and set the negative cable aside.

VEHICLE DISASSEMBLY

This section covers console and dash component removal.

REMOVE CONSOLE SIDES

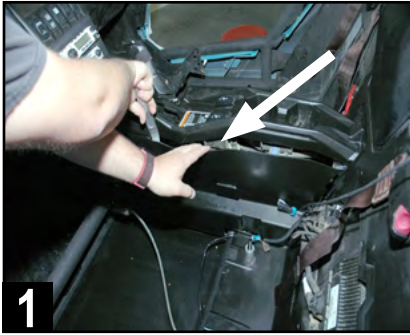

1 Remove driver's side console side panel using a pry tool from the top to gently release the pressure-fit clips.



2 Remove passenger's side console side panel using a pry tool from the top to gently release the pressure-fit clips.



3 Remove front of center console side panel on passenger's side (footwell area) using a pry tool to gently release the pressure-fit clips.

REMOVE CENTER DASH HARDWARE & CLIPS



4 Move gear selector all the way back (away from the dash). Remove two T-30 screws from the area just forward of the gear selector when in park.



5 Remove top center plastic cover above dash pocket by pushing up on the front pocket edge above the lighter socket, then pulling toward you.



6 Next, remove two additional T-30 screws located beneath the forward edge of the top center plastic cover location, just forward of fuse box.



7 Identify four visible push pin clips on the outer edges of the center pocket. These secure the flanges of the left and right side dash speaker panels.



8 Gently remove the four visible push pin clips with a panel removal tool or special panel clip pliers (not needle nose) as shown.

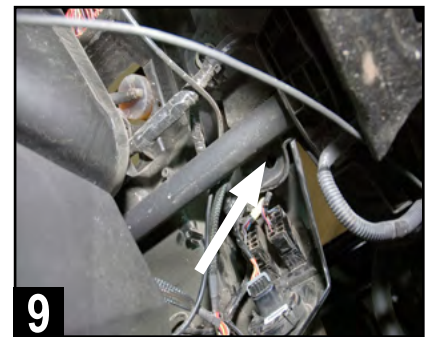

9 Remove one additional hidden push pin under the driver's side dash, between the steering wheel and console, just forward of the tubular chassis support.

VEHICLE DISASSEMBLY

This section covers left and right side top dash speaker panels and gauge cluster removal.

REMOVE PASSENGER & DRIVER TOP DASH PANELS

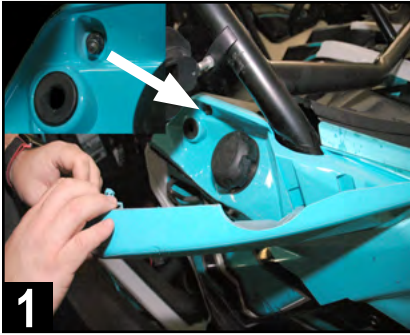

1 Remove gas filler access door on passenger side. Note above the grommet for the retainer clip, there is a 10mm nut attaching a mounting screw.

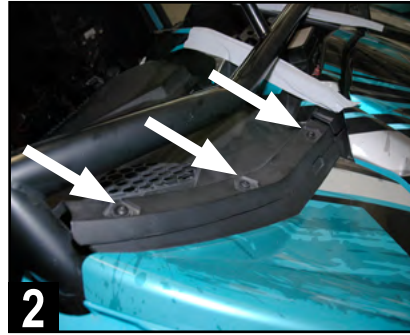

2 Remove three T-30 screws from the top edge of the passenger's side dash where the hood line meets the dash as indicated.

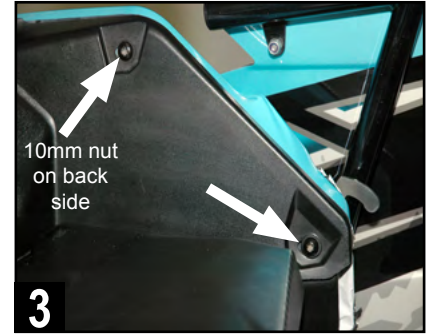

3 Remove the remaining two T-30 screws on the side edge of the panel. The top screw requires the 10mm nut loosened with a 10mm socket.

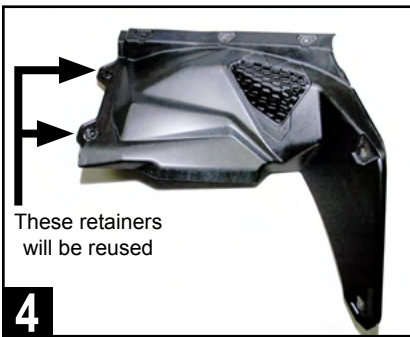

4 Gently remove passenger side speaker panel and set aside. The center push pin retainer clips will eventually need to be transferred to the new panel.

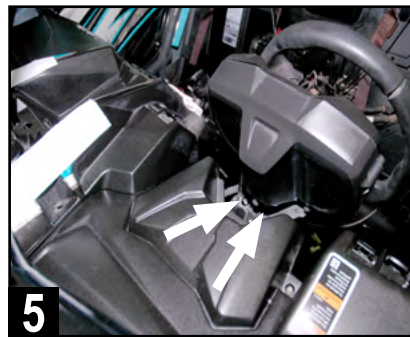

5 Drop steering wheel position to access two T-30 gauge cluster screws. Cluster removal helps removal of the panel and access for amplifier installation.



6 Remove two T-30 screws holding the gauge cluster with a 10mm socket (below) and T-30 driver (above). Set gauge cluster aside when done.

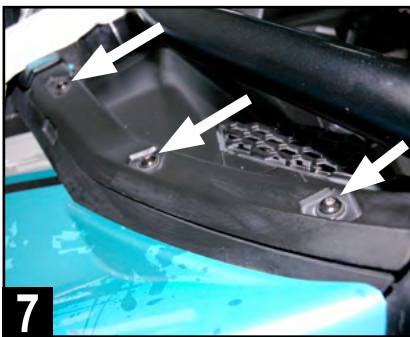

7 Remove three T-30 screws from the top edge of the driver's side dash where the hood line meets the dash as indicated.



8 Remove two T-30 screws on the side edge of the panel. Next, remove two remaining T-30 screws behind gauge cluster area as indicated.



9 Pull panel* carefully to access switches and unplug them to fully remove driver's side panel. Set aside as with passenger dash panel for later reuse.

*Note: If equipped with Smart-Lok differential feature, remove the module with four 8mm screws from underside of driver's dash panel.

VEHICLE DISASSEMBLY

Removal of the center console inner cover facilitates routing wire harness from bus bar into the dash area.

INNER COVER OF CENTER CONSOLE

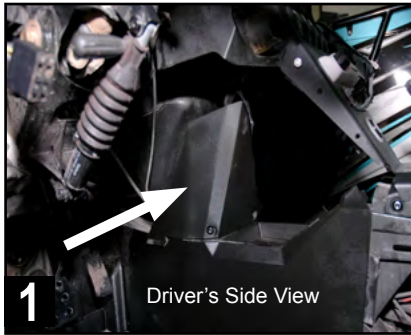

1 Prepare to remove forward inner cover of the center console. Note - some modified vehicles may have aftermarket console electronics present.

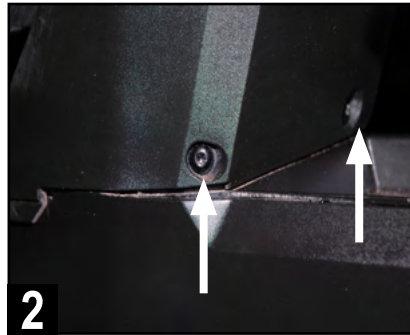

2 Remove two T-30 screws on the lower front of center console.

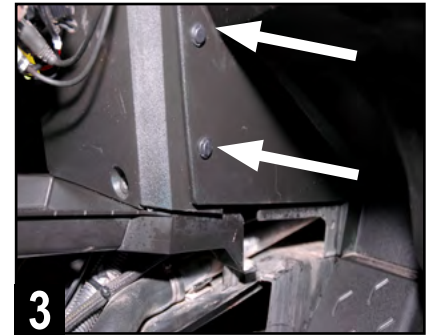

3 Finally, remove two push pins on passenger's side of cover panel.

DISASSEMBLY IS COMPLETE!

WIRING HARNESS PREP

The next steps are going to be running the wiring harnesses throughout the console and dash area.

Be sure to lay every harness and cable out to ensure you have identified each one and nothing is missing.

For safety precautions, **remove the main 70a MAXI fuse from the black fuseholder** in the main power harness at this time. This will prevent the wiring from shorting during the installation work after connecting power at the bus bar in the passenger side center console.



70a MAXI Fuse

ILLUMINATION-READY HARNESS

The main wiring harness has small red and black wires with mated connectors that enable illumination at the speaker location using optional illuminated speaker rings (not included with this kit). Both the front and rear speaker locations are pre-wired for this feature in the harness to facilitate an easier installation of the illuminated rings. Simply make sure the red and black wires with mated connectors are connected to the front and rear speaker harnesses during the installation of the main wiring harness.

Please check www.MBQuart.com for options if you wish to purchase and install these illuminated speaker rings.

ROUTE WIRING HARNESS

This section covers connecting the main harness to the bus bar in the passenger side center console (toward the back section) and running the various breakout harness sections to their respective locations.

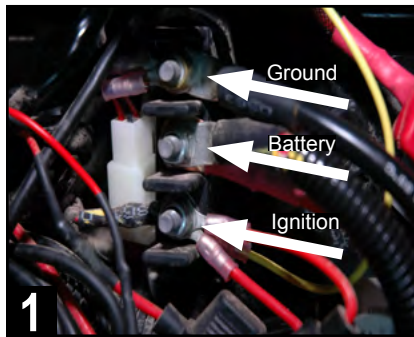

1 Identify bus bar in passenger side center console. Top is chassis ground, middle is constant +12v power (battery) and bottom is +12v accessory.

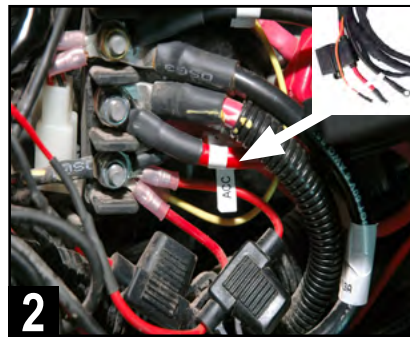

2 Connect the ground (black), +12v constant (large red with fuseholder) and +12v ACC (orange) on the audio system harness to bus bar locations.



3 Locate rear speaker harness and lay out next to main harness. Route this harness with the others even if no rear speakers are used at this time.

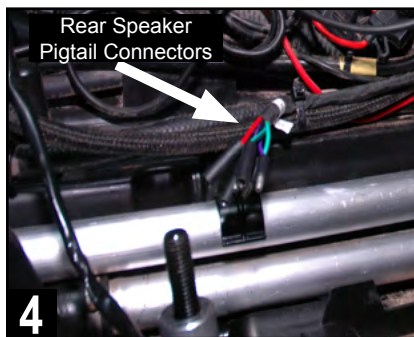

4 Place the rear speaker harness pigtail connectors just behind the bus bar (about where the rear seat bolt is located) and zip tie in place.

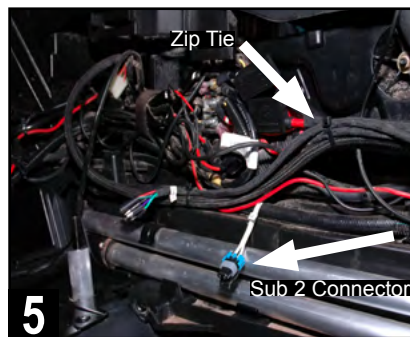

5 Next, route the rear speaker harness up to join the main & subwoofer harnesses and zip tie in place. Note the "Sub 2" connector stays in that area.

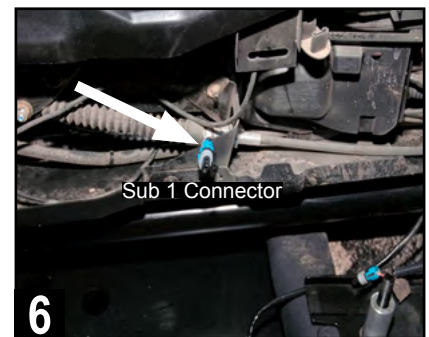

6 Route the "Sub 1" connector through the console wiring to exit on the driver's side in about the same mid-console location as "Sub 2" connector.

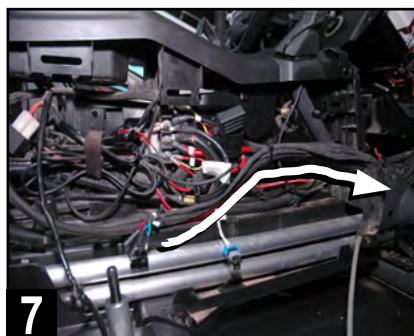

7 Begin routing the main, subwoofer and rear speaker harnesses along the passenger side console and zip tie to factory wiring.



8 Route the harnesses upward behind the center dash where the panel was removed for easier access. Secure with zip ties to factory wiring.



9 Route harnesses up to steering column support bar. Finally, route passenger speaker harness from right speaker location to left harness area.

SOURCE UNIT PREPARATION AND WIRING

This section covers the preparation steps necessary to wire and pre-drill mounting for the source unit.

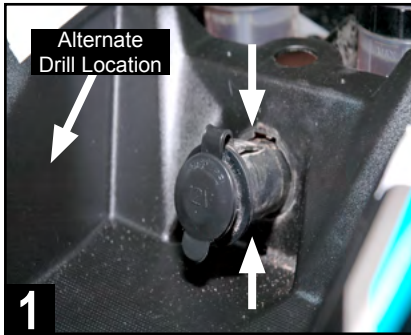

1 Remove power plug to facilitate source unit wiring passage by pressing in on the top and bottom retention clips. Or, drill a 1" hole on left side of plug.

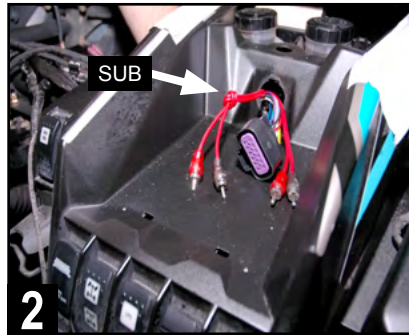

2 Route source unit wiring pigtail and two RCA audio cables to the area where the other harnesses have been routed on the driver's side. Note knotted RCA to designate SUB.

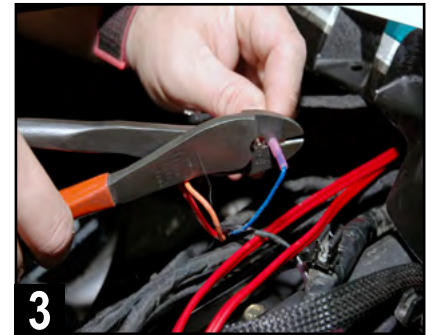

3 Make four (4) crimped source unit wiring connections by matching wire colors as shown. Tape unused wires.

- RED - +12v Battery (Constant)
- ORANGE - +12v Accessory (ACC)
- BLUE - Amplifier Turn On
- BLACK - Chassis Ground

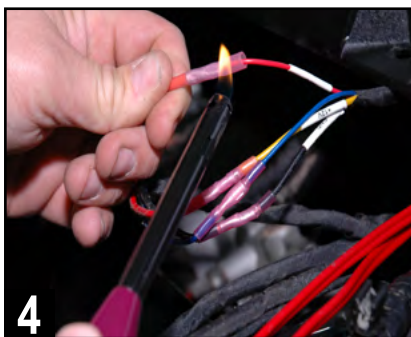

4 Use a lighter or heat gun to heat shrink and seal the crimped connections. This ensures no moisture will penetrate the wiring.

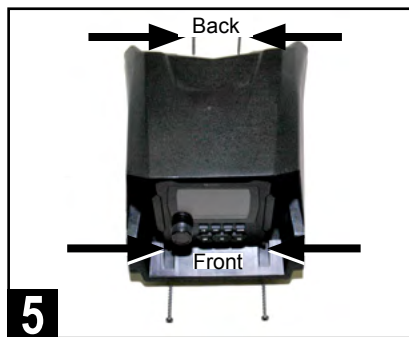

5 Take note of required drilling holes for mounting of the source unit's housing as shown. Two (2) in front and two (2) at the back.



6 Set source unit housing in place to locate four (4) mounting holes required for final mounting. Locate and mark dimples for verification.



7 Using a 9/64" drill bit, drill two (2) mounting holes in the dimpled areas as indicated. As the material is plastic, there is very little pressure needed.



8 Drill the remaining two (2) mounting holes at the back of the housing as indicated. Again, as the material is plastic very little pressure is needed.

Set the source unit and housing aside until the installation is ready for connections, testing the audio system and final fitting.

Note: If you are adding an optional USB and Auxiliary input accessory plug (model PSAP-2 or PSAP-2S) to the installation, complete that mounting wire run at this time so that upon final installation all wiring is ready to connect to the source unit.

AMPLIFIER INSTALLATION

This section covers installation of the amplifier(s) included with the Stage 2, 3 and 5 audio system kits. An optional third amplifier and second subwoofer are covered on pages 11 & 12 of this manual. See page 17 for more details on initial amplifier settings (steps 2 and 3 below).

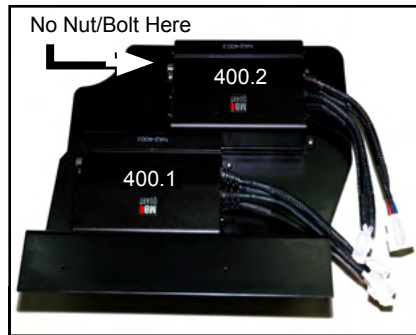

Attach amplifiers* to mounting plate with included hardware as indicated. Use only three nuts/bolts on 400.2 (2-ch) amplifier due to tube frame clearance.

*Note: Amplifiers appear upside down, which allows for easier access to adjustments of gain, crossover, etc.



Make initial LEVEL and HP crossover settings as indicated on the 400.2 amplifier.

- X-OVER SWITCH - High Pass (HP)
- LEVEL DIAL - 1/2 of the way up from 9V
- HP DIAL - Approximately 80Hz
- LP DIAL - Unused in this application



Next, make initial LEVEL, LPF crossover and SUBSONIC filter settings as indicated on the 400.1 amplifier.

- BOOST SWITCH - 0dB Position
- LEVEL DIAL - 3/4 of the way up from 9V
- LPF DIAL - Approximately 100Hz
- SUBSONIC DIAL - Approximately 31Hz



From the top side, place amplifier plate in the intended location behind silver brake booster against the driver's side firewall for test fitting.

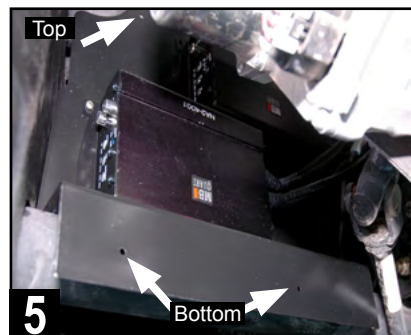

Using a felt marker or punch, mark mounting holes for drilling. There are three holes to mark and drill. Two at the bottom, one at the top corner.



Drill mounting holes in the marked locations using a 1/8" drill bit. You may wish to remove the amp plate before drilling to avoid scratch marks.

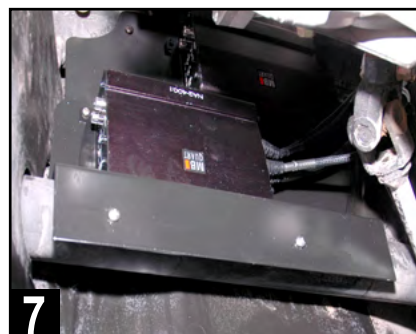

Mount amplifier plate in place using the supplied 1/2" length Phillips head sheet metal screws.



Connect RCA audio cables to the appropriate amplifier according to your designation at the source unit (knotted, labeled, etc.).



Connect the electrical and speaker plugs for each amplifier as labeled*. Tie up excess wiring to factory wires and avoid any moving parts.

*Note: There is a third electrical connector and a "SUB 2" speaker connector intended for the optional second subwoofer option.

MAIN SUBWOOFER INSTALLATION (SUB 1)

This section covers the installation of the primary subwoofer included in Can-Am X3 Stage 3 and 5 systems. MB Quart recommends this is installed under the driver's seat, although it can fit under either front seat.



1 Identify front enclosure brackets. Orientation is referenced to the logo. Left and right are stamped "L" and "R" on the bracket and enclosure.



2 Remove the factory-supplied aluminum spacers from rear bolts of seat mounts*. Replace with supplied MB Quart spacers for bracket tolerance.

*Note: If installing into a 4-seat model, these instructions are intended for the front seats only.



3 Load subwoofer enclosure into under seat position by angling the front under the support bar for clearance of the brake line and to sit level.

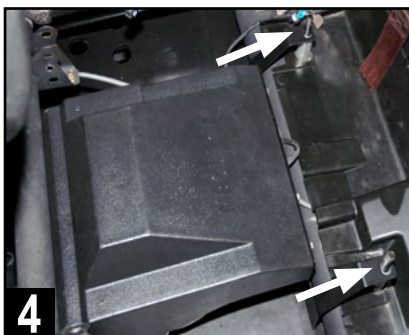

4 Align rear enclosure brackets over threaded seat mounts so they sit atop the aluminum spacers. Route wiring toward center console area.



5 Attach front left side mounting brackets to the subwoofer enclosure using two 1/2" bolts and a lock washer on each.

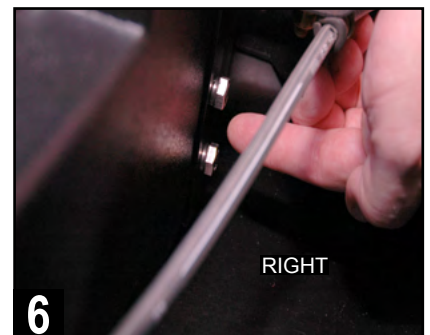

6 Attach front right side mounting brackets to the subwoofer enclosure using two 1/2" bolts and a lock washer on each.

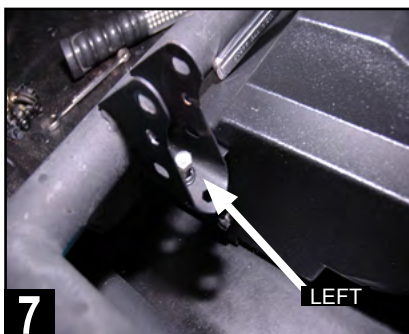

7 Attach a 1/2" bolt, lock washer and flat (black) washer through the left side seat mount bracket to the threaded insert of the left enclosure bracket.

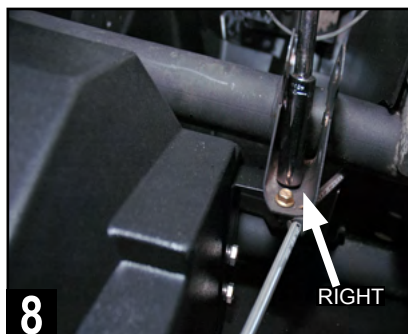

8 Attach a 1/2" bolt, lock washer and flat (black) washer through the right side seat mount bracket to the threaded insert of the right enclosure bracket.



9 Connect the enclosure's wiring pigtail to the connector at the side of the console labeled "Sub 1."

OPTIONAL SUBWOOFER AMPLIFIER INSTALLATION (FOR SUB 2)

This section covers the installation of the optional subwoofer amplifier included in MBQX-SUB-2, either as the second subwoofer amplifier in a Stage 3 or 5 system using new amp plate shown, or as the “add on” option for an existing Stage 2 system using the dual amp plate installed in the vehicle (requires removal).



1 Begin by identifying the amplifier mounting plate and hardware. Stage 3 and 5 systems require the accessory amp plate MBQX-SUB-ACC-1.



2 Attach 400.1 amplifier to mounting plate with included hardware as indicated. Use only three nuts/bolts due to tube frame clearance.



3 Next, make initial LEVEL, LPF crossover and SUBSONIC filter settings as indicated on the 400.1 amplifier (Sub Amp 2).

- BOOST SWITCH - 0dB Position
- LEVEL DIAL - 3/4 of the way up from 9V
- LPF DIAL - Approximately 100Hz
- SUBSONIC DIAL - Approximately 31Hz

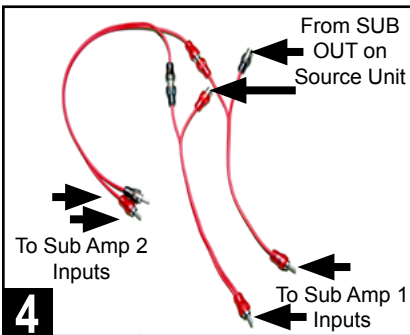

4 Unplug the SUB RCA audio input cables at the 400.1 amplifier on the dual amp plate (Sub Amp 1). Connect splitters and RCA extension as shown*.

*Note: Which RCA plug goes to left or right inputs doesn't matter as the amp output is mono

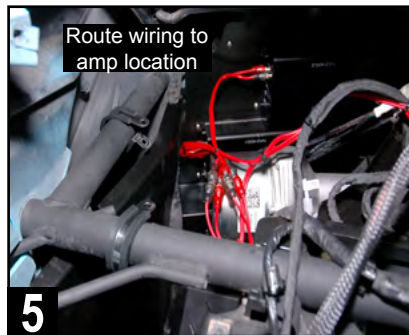

5 Route power, speaker wiring and RCA extension to amplifier location (near frame tubes). Place mounting clamps in initial locations as shown.



6 Place amplifier & plate into its location. Attach the supplied Phillips screws and 7/16" nuts through the clamp holes and tighten until amplifier is secure.



7 Connect the RCA audio cable extension to Sub Amp 2 inputs. Position of right or left RCA plugs does not matter because the output signal is mono.



8 Connect the speaker (Sub 2) and power harness connectors as shown.

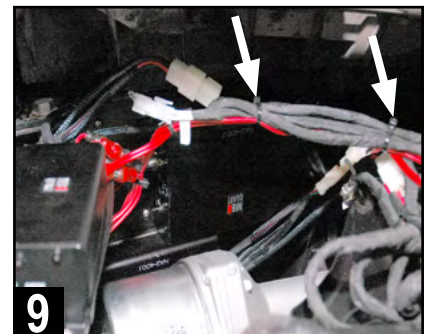

9 Zip tie the wiring neatly to ensure no connectors come loose. Avoid any moving parts (such as steering mechanism), moisture or heat sources.

ADD-ON SUBWOOFER INSTALLATION (FOR SUB 2)

This section covers the installation of the 10" optional subwoofer included in MBQX-SUB-2, either as the second subwoofer in a Stage 3 or 5 system, or as the "add on" subwoofer option for a Stage 2 system. This upgrade requires front passenger seat removal prior to installation. Refer to Page 3 for procedure.

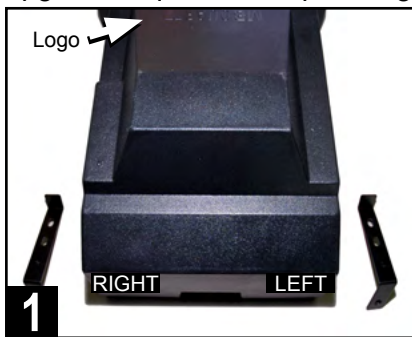

1 Identify front enclosure brackets. Orientation is referenced to the logo. Left and right are stamped "L" and "R" on the bracket and enclosure.



2 Remove the factory-supplied aluminum spacers from rear bolts of seat mounts*. Replace with supplied MB Quart spacers for bracket tolerance.

*Note: If installing into a 4-seat model, these instructions are intended for the front seats only.



3 Load subwoofer enclosure into under passenger seat position by angling the front under the support bar for clearance of the brake line and to sit level.

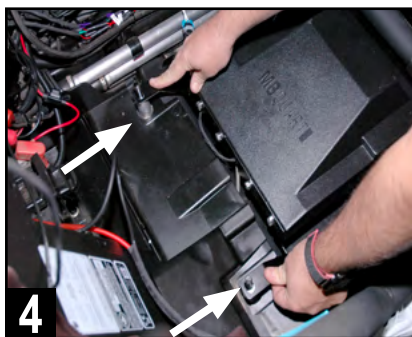

4 Align rear enclosure brackets over threaded seat mounts so they sit atop the aluminum spacers. Route wiring toward center console area.

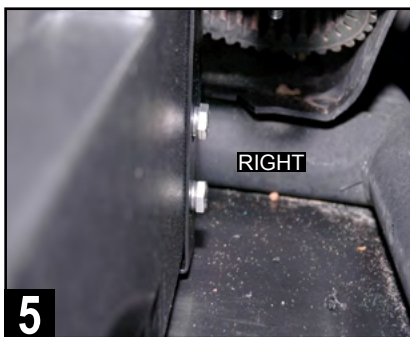

5 Attach front right side mounting brackets to the subwoofer enclosure using two 1/2" bolts and a lock washer on each.

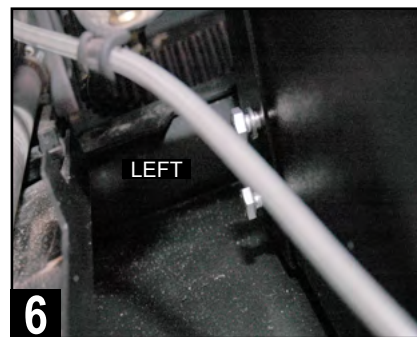

6 Attach front left side mounting brackets to the subwoofer enclosure using two 1/2" bolts and a lock washer on each.

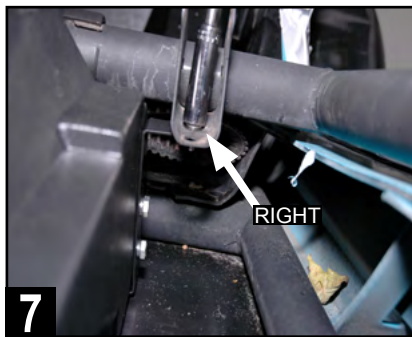

7 Attach a 1/2" bolt, lock washer and flat (black) washer through the left side seat mount bracket to the threaded insert of the left enclosure bracket.

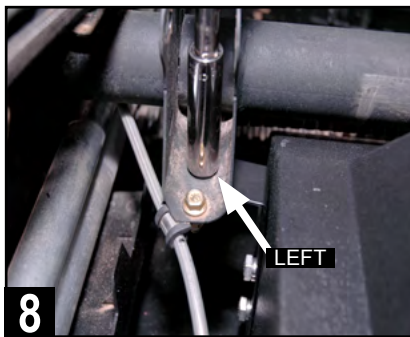

8 Attach a 1/2" bolt, lock washer and flat (black) washer through the right side seat mount bracket to the threaded insert of the right enclosure bracket.

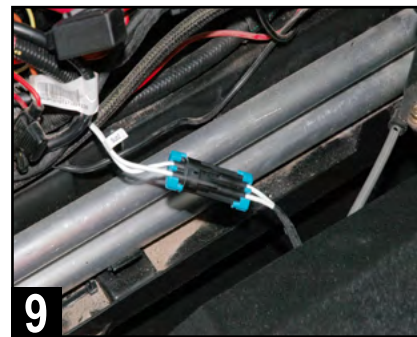

9 Connect the enclosure's wiring to the connector at the side of the console labeled "Sub 2."

REAR SPEAKER PODS INSTALLATION

This section covers the wiring and installation of rear speaker pods. Note that the wiring harness is pre-wired for illumination to add illuminated speaker rings (not included with the Stage 5 kit).

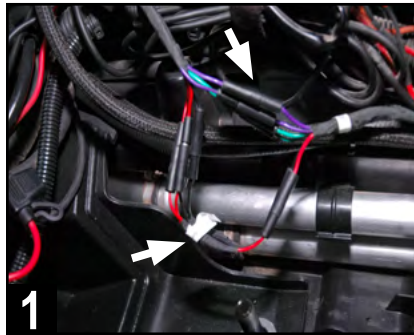

1
Connect rear speaker harness* to main harness in console near bus bar. If illumination capability is used, also connect red/black illumination wires.

*Note: Four-door models require the included extension rear speaker harness. See next page.



2
Remove cover at the back wall above center console by pulling on the top to release. This will provide access to the engine area for harness routing.

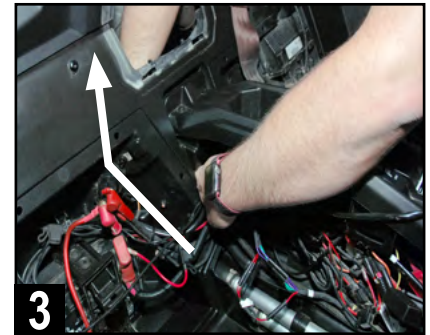

3
Carefully route the rear speaker wiring harness from passenger side console area into the engine area as shown*.

*Note: If rear speaker harness extension was used, connect the standard rear speaker harness at this step to run into engine area.

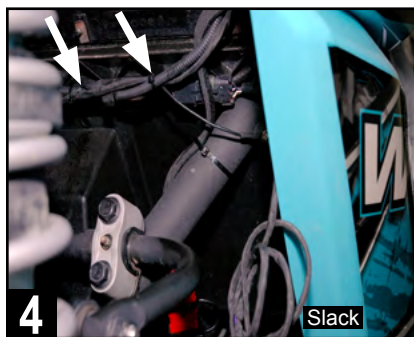

4
Route rear speaker wiring to left and right sides using zip ties to attach to factory wiring harnesses. Leave slack hanging in wheel well area.



5
On driver side, remove two T-30 Torx screws over roll cage mounting points. Gently release pressure clip and remove cover panel.

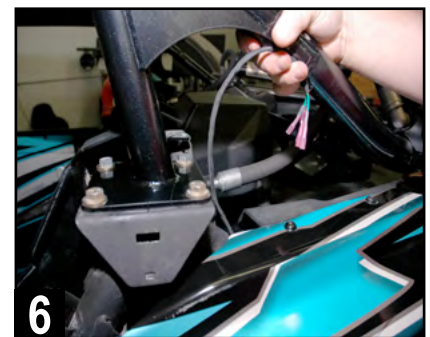

6
Next, reach down to rear speaker wiring slack and pull upward with enough length to reach the rear speaker pod location. Lay wiring aside.

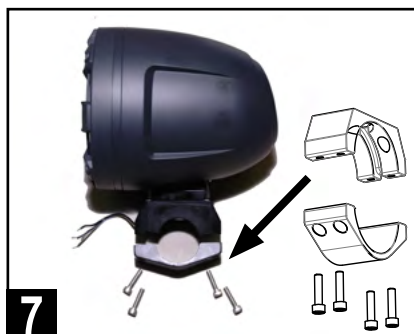

7
Remove four 5mm Allen head screws from both rear speaker pod clamps to prepare for pod installation on roll cage.

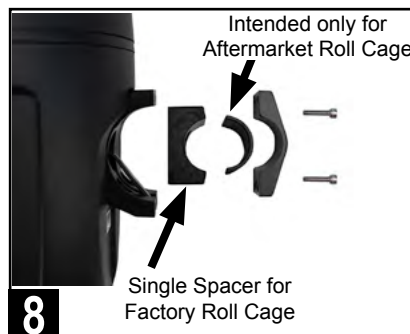

8
Place included rubber spacer on **bottom clamp** as indicated. Factory roll cage uses 1.875" tubing and the corresponding **single 1.88 bottom spacer***.

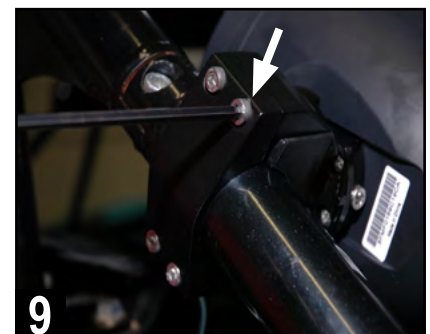

9
Secure driver side speaker pod clamps to roll cage by reinstalling the four 5mm Allen head screws. Alternate tightening until secure.

*Note: Aftermarket roll cages may use the other included spacer on the top bracket if tubing diameter is slightly smaller at 1.75".

REAR SPEAKER PODS INSTALLATION (Continued)

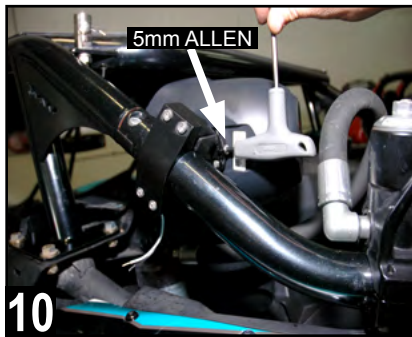

Loosen the 5mm Allen screw on the swivel base to position driver side pod to preferred setting. Tighten Allen screw once final position is achieved.



Make two (2) crimped speaker wiring connections as indicated. Illumination wiring is optional with accessory rings.

- SOLID GREEN - Speaker + (White Wire)
- GREEN/BLACK - Speaker - (Black Wire)
- RED - Illumination + (Optional Grille Required)
- BLACK - Illumination -



Use a lighter or heat gun to heat shrink and seal the crimped connections to ensure no moisture penetration.



Using high-quality electrical tape, cover the connections with the electrical tape to insulate from moisture and electrical shorting.



Replace cover panel over roll cage mounting points with the original two T-30 Torx screws. Leave wiring loose until next step.



Using supplied zip ties, secure the taped wiring in place on the roll cage as indicated.

NEXT STEPS - REPEAT INSTALLATION ON PASSENGER SIDE

Repeat the installation steps 6-15 on the passenger side rear speaker pod. When connecting the speaker wiring, observe the wire colors listed on the right of this note. Heat shrink and tape up connections.

| PASSENGER SIDE REAR SPEAKER WIRING |
|---|
| • SOLID PURPLE - Speaker + (White Wire) |
| • PURPLE/BLACK - Speaker - (Black Wire) |
| • RED - Illumination + (Optional Grille Required) |
| • BLACK - Illumination - |

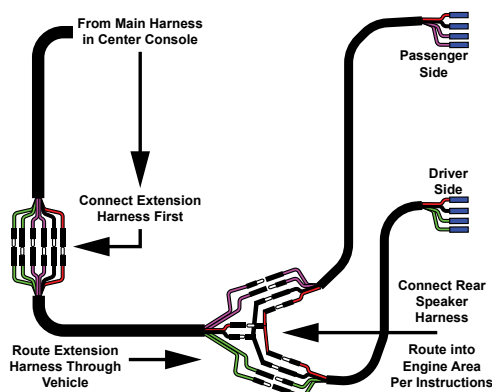

FOUR-SEAT CAN-AM X3 MODELS - EXTENSION HARNESS

On four-seat Can-Am X3 vehicles, an extension harness (included in the Stage 5 kit) must be used. Connect the extension rear speaker harness at the console area near the bus bar where the rear speaker pigtail was positioned. Route this harness through the vehicle and past the rear seats. Then, connect the standard rear speaker harness (with separate left and right side wiring). Run rear speaker wiring together through into the engine area and route individually to speaker locations as instructions on the previous page describe.

FRONT SPEAKER INSTALLATION

This section covers final installation of the passenger's side front speaker panel and temporary installation of the driver's side speaker panel. Final installation of the driver's side speaker panel occurs after the system is tested and gone through a thorough inspection prior to reassembly.

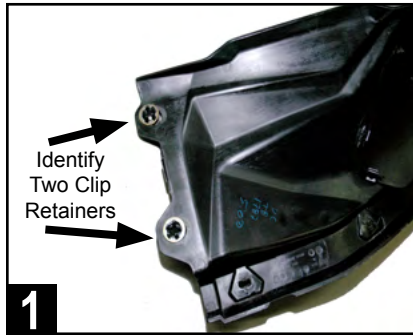

1 Locate the factory front left and right speaker panels and identify two mounting clip retainers and washers that need to be removed on each.



2 From bottom side, gently remove mounting clip retainers as indicated. This can be done with your fingers. Do this for both passenger and driver side.

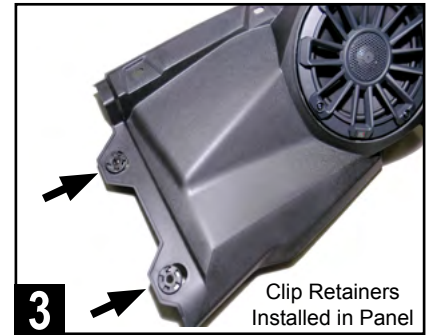

3 Replace these mounting clip retainers and washers in the same locations of both MB Quart speaker panels in your Can-Am X3 kit. It's a direct fit.



4 Connect passenger side speaker to gray wiring routed earlier to speaker area. Red/black wires are for optional illuminated speaker rings.

- SOLID GRAY - Right Front Speaker (+)
- GRAY/BLACK - Right Front Speaker (-)



5 Begin to set passenger side speaker panel in place by loading the edge nearest the center with the clip retainers into position as shown.

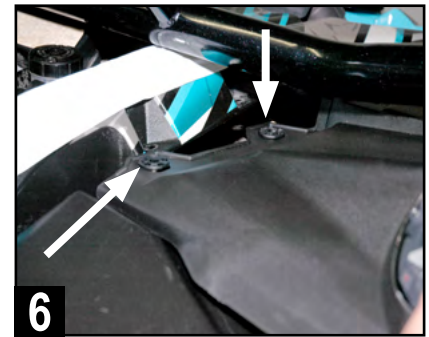

6 Pull center edge of panel up to align clips with the respective dash receiver holes. This is a crucial step to facilitate the correct overall panel fit.

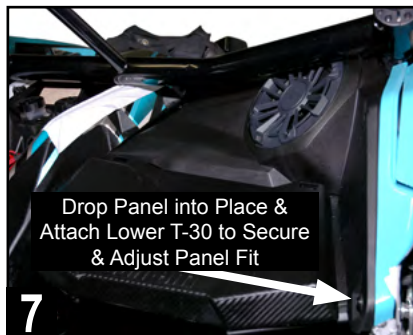

7 Next, drop the speaker edge of panel into place*. Attach lowest T-30 screw into place to allow check of final panel fit and to ensure all clip holes align.

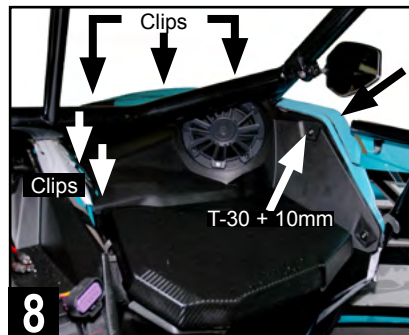

8 Secure the front speaker panel by reinstalling all the remaining clips and hardware in the same locations removed during the disassembly process.

***AFTERMARKET ROLL CAGES**
Although MB Quart front speakers come pre-installed in the Can-Am replacement panels, they may require removal from the panel to fit low-slung aftermarket roll cages that fit close to the hood area.

In these cases where fit is tight or would damage the speaker due to the roll cage position, remove the speaker from the panel first, install the panel in the vehicle, then connect and install the speaker into the panel.

FRONT SPEAKER INSTALLATION (Continued)

This section continues front speaker installation focusing on the driver's side.

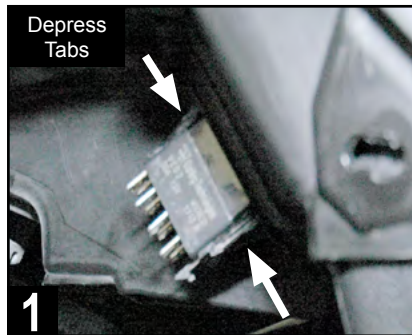

1 Remove switches on lower left of original driver's side dash panel by depressing the tabs on the top and bottom of the back of switch.

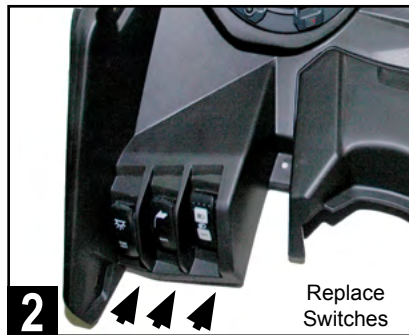

2 Replace switches in the same locations within the new MB Quart driver's side dash panel by simply pushing each into its mounting opening.

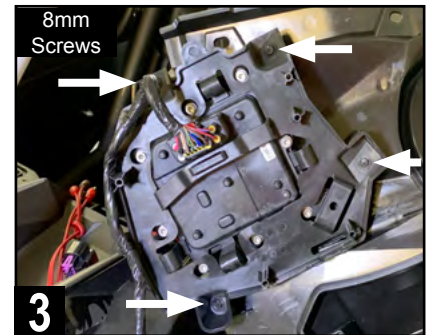

3 If the vehicle has the Smart-Lok differential control module, attach to the underside of the new dash panel with the original four 8mm screws.

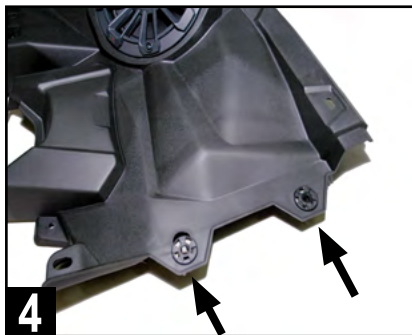

4 Ensure the clip retainers and washers from the original dash panel have been reinstalled correctly before proceeding.



5 Connect driver's side speaker to white speaker wiring near the amplifier harness area. Red/black wires are for optional illuminated speaker rings.

- SOLID WHITE - Left Front Speaker (+)
- WHITE/BLACK - Left Front Speaker (-)
- RED - Illumination + (Optional Grille Required)
- BLACK - Illumination -



6 Set panel temporarily in place without attaching any hardware or clips. Do not yet plug in switches in case amplifier adjustments are needed.

DOUBLE CHECK INSTALLATION STEPS TO THIS POINT

Take a few minutes to double check all of the installation steps to this point ensuring the amplifiers, speakers and wiring has all been connected as shown in these instructions.

PROCEED TO THE NEXT PAGES TO CONFIRM SETTINGS AND BEGIN TESTING THE SYSTEM.

AMPLIFIER SETTINGS

Before source unit and dash reassembly, make (or verify) the following settings the amplifiers. See the INITIAL TESTING and FINE TUNING sections for additional information on final system adjustments and personalized settings. The chart below provides general crossover filter and bass boost switch settings depending on the Can-Am X3 UTV-Tuned Audio package you have.

| TUNED PACKAGE | TWO-CHANNEL AMPLIFIER | MONO AMPLIFIER |
|-----------------|---|-----------------------------------|
| MBQX-STG5-1 | HP-OFF-LP/BP Switch to HP - High Pass (80Hz) | Bass Boost to 0dB LPF at 100Hz |
| MBQX-STG3-1 | HP-OFF-LP/BP Switch to HP - High Pass (80Hz) | Bass Boost to 0dB LPF at 100Hz |
| MBQX-STG2-RAD-1 | HP-OFF-LP/BP Switch to - High Pass (80Hz) | N/A |
| MBQX-STG2-1 | HP-OFF-LP/BP Switch to - High Pass (80Hz) | N/A |
| MBQX-SUB-2 | N/A | Bass Boost to 0dB LPF at 100Hz |

This manual assumes the full Stage 5 System and provides the information for initial settings accordingly.

STEP 1 – ADJUST TWO-CHANNEL AMPLIFIER

Make the following initial adjustments to the NA2-400.2 shown at right:

- **X-OVER** - Switch to “HP” position.
- **LEVEL** - Rotate control to halfway starting at 9V (dial pointing up). This represents an input level that will closely match the source unit’s output at full volume allowing the amplifier to achieve full power without notable distortion.
- **HP** - Rotate control to halfway from 15 Hz (pointing up). This is approximately 80HZ.
- **LP** - Not used in this application (position does not matter).

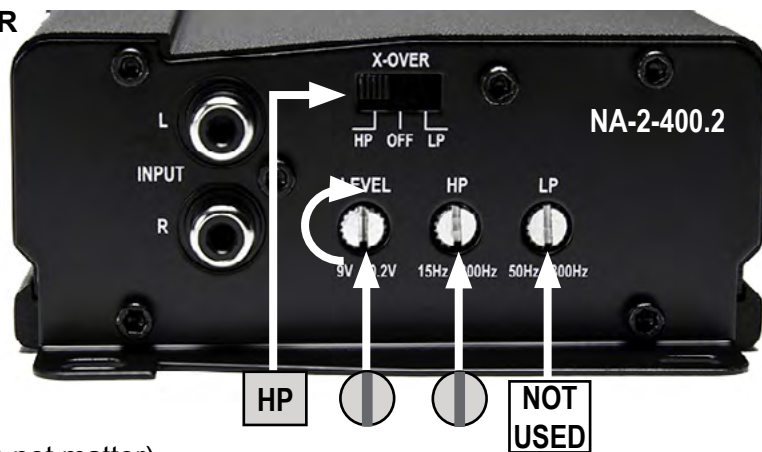

STEP 2 – ADJUST MONO AMPLIFIER

Make the following initial adjustments to the NA2-400.1 shown at right:

- **BOOST** - Switch to “0dB” position.
- **LEVEL** - Rotate control to 3/4 of the rotation starting at 9v (dial pointing side to side). This represents an input level to match the source unit’s output at full volume allowing the full power without notable distortion. Note source unit’s “SUB OUT” level setting on next page (35dB) to correlate with this recommendation.
- **LPF** - Rotate control to 1/4 turn starting at 50 Hz (dial pointing diagonal as shown). This is approximately 100Hz. Note that the source unit’s SUB OUT frequency setting on the next page is also set to 100Hz to correlate with this recommendation.
- **SUBSONIC** - A subsonic filter protects the subwoofer from over excursion. Rotate control to 1/4 turn starting at 15Hz (dial pointing diagonal) as shown. This is approximately 31Hz.

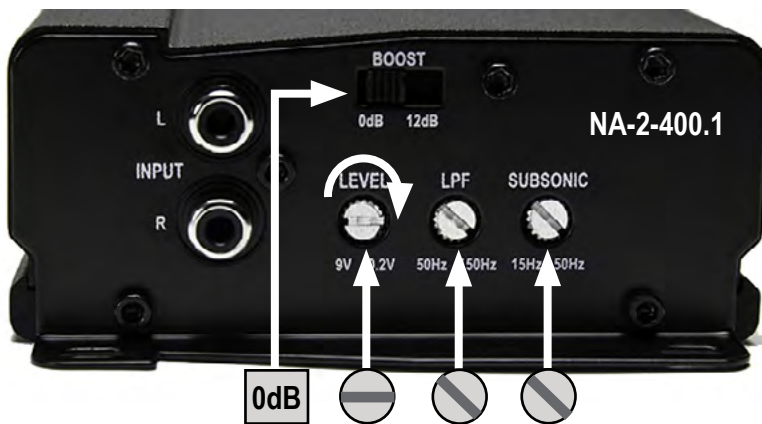

INITIAL TESTING

Confirm that everything is working as intended before final tuning, fitting and reassembly.

STEP 1 – RECONNECT THE BATTERY

First, ensure the battery is fully charged. Using a 10mm socket, then reconnect the negative terminal of the negative battery cable as indicated.



STEP 2 – CONNECT SOURCE UNIT

Connect the electrical plug and two RCA audio cables to the source unit. The “FRONT” RCA outputs connect to the high frequency (400.2) amplifier. The green “SUB” RCA outputs connect to the low frequency (400.1) amplifier. Temporarily set housing in place, but do not yet attach mounting screws. This will allow for any corrections of wiring if needed.



STEP 3 – INSERT MAIN FUSE AT BUS BAR

With the source unit connected, place the 70a MAXI fuse in the fuseholder near the bus bar main harness connection.

STEP 4 – TURN ON IGNITION

Turn the ignition key to the ACC position.

STEP 5 – INITIAL CHECKS

The following instructions are for confirming connectivity and basic functionality. Refer to the full manual for the GMR-LED source unit to use features like Bluetooth® pairing, adjusting treble and bass or working with the EQ. Push the PWR button on the source unit and check the system for all of the following:

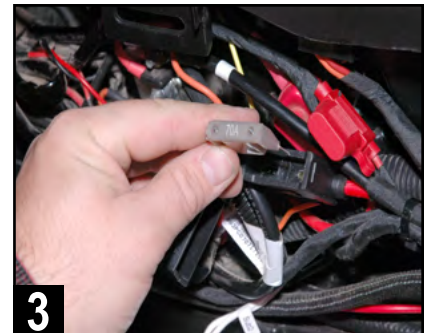

- **POWER ON** - Source unit lights up and responds to button presses.
- **USB INPUT** (if used) responds when selected.
- **AUX 3.5mm INPUT** (if used) responds when selected.
- **BT MUSIC** - Follow the pairing instructions for source unit and test a Bluetooth® source.
- **AM/FM RADIO** - Unless you have installed and AM/FM antenna, you will only hear static.
- **SPEAKERS** - Confirm all speakers play the correct range of frequencies (lows coming from the subwoofer, mid to high coming from front and rear speakers).
- **CORRECT LEFT/RIGHT BALANCE** - Make sure you are using the controls on the source unit to confirm “LEFT” is the left-side channel and “RIGHT” is the right-side channel. There will be no change on the fader front/rear speakers as all speakers are on the same two-channel (400.2) amplifier and “FRONT” output.
- **SUB FREQUENCY and LEVEL SETTING** - In the settings menu, set the source unit’s SUB OUT (Low Pass) crossover at 100Hz. Next, set the source unit’s SUB OUT level at 35dB for the initial testing. A level setting of 35dB will allow the recommended gain control settings on the subwoofer amplifier to perform distortion-free, while also allowing you to fine tune any bass-heavy music by easily reducing the sub level setting from the source unit.
- **AMPLIFIERS** - If the speakers are playing, the amplifiers are on. Confirm settings are correct if something doesn’t sound exactly right. **CONFIRM ALL SPEAKERS ARE CONNECTED TO THE CORRECT AMPLIFIER** before making any further adjustments. Refer to page 9, 11 and 17 for initial amplifier settings during the amplifier plate installation. If everything is working and producing sound, proceed to the next section - Fine Tuning.

FINE TUNING

After you have confirmed and tested that all components are working, you can fine tune the amplifier settings. Through hundreds of installations we have determined the following settings are ideal for the Can-Am X3 UTV-Tuned Audio Packages. Reference source unit volume level for these settings is 30-35 with no boost in bass, treble or EQ settings.

NOTE – Gain control, it is important to adjust each amplifier gain as described in the manual. Remember, these settings are NOT volume controls. Gain controls, properly adjusted help properly balance the system sound between lows, highs and minimize distortion that comes from the source unit. Listen for a clear, crisp audio sound. The ideal gain setting should allow full volume from the source unit without audible distortion.

A
Settings

The illustrations below describe the various controls. Refer to the illustration that matches your amplifier.

- 1** **GAIN Adjustment**
 The gain control purpose is to match the output of your source signal to the amplifier. Refer to the section B below for detailed instructions.
- 2** **X-OVER Switch**
 This switch will set the amplifier to have a full frequency output or to filter out high or low frequencies. The NA2-400.2 offers either a low pass (LP) or high pass (HP) filter.
- 3** **Frequencies Adjustment**
 The Low Pass Filter will cut off the frequencies above the setting. The High Pass Filter will cut off the frequencies below the setting.
- 4** **SUBSONIC Adjustment**
 The Subsonic Filter will cut off the frequencies below the setting. If using with a subwoofer, the setting should be set between 15-25Hz.
- 5** **BOOST Switch**
 The Boost Switch will increase the signal 12dB at 45Hz. Be aware this setting can cause distortion if the gain is not set properly.

Two Channel Amplifier
NA2-400.2

Mono (Subwoofer) Amplifier
NA2-400.1

B
Level Setting

This is a critical step to insure your amplifier is properly adjusted to match the signal output level of your source unit.

THIS IS NOT A VOLUME CONTROL!

1. If possible, with the source unit off, confirm that the primary volume control is turned down (counter clockwise).
2. Turn on the source unit (CD, or MP3 player). Re-confirm that the volume is turned down. Make sure the source unit controls; balance, fader, bass and treble are all set to center or "0" adjustment. Make sure that the green LED on the end of the amplifier is illuminated.
3. Play a clean musical selection of which you are very familiar. CD is preferred. Do not use radio signals for level setting. Hit play and start turning the volume of the source unit up.
4. Stop increasing the source unit volume when you reach 3/4 (about 75%) or until you hear speakers begin to slightly start producing distortion.
5. Increase the amplifier gain (clockwise) until distortion is heard, then back the level down (counter clockwise) until the distortion is eliminated. Small adjustments may need to be made to balance the levels of multiple amplifiers.

MBQUART
MUSIC. DEFINED.

19

VEHICLE REASSEMBLY

As you begin reassembly, take the time to ensure no fastener, screw or clip is excluded. Review any prior disassembly steps to ensure you don't miss any hardware during reassembly.

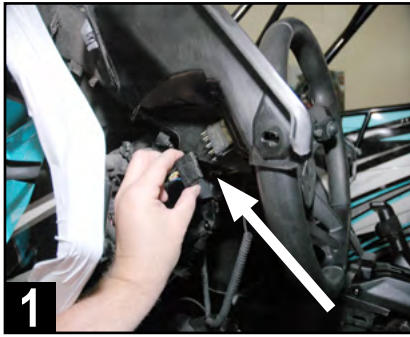

1 Plug in all switch wiring on back of the driver side front speaker panel. Test switch functions to ensure they are correctly connected.



2 Place driver side speaker panel into its final position*. Check fit so that all open hardware and clip holes are aligned properly.

***AFTERMARKET ROLL CAGES**
Although MB Quart front speakers come pre-installed in the Can-Am replacement panels, they may require removal from the panel to fit low-slung aftermarket roll cages that fit close to the hood area.

In these cases where fit is tight or would damage the speaker due to the roll cage position, remove the speaker from the panel first, install the panel in the vehicle, then connect and install the speaker into the panel.

- 3** Secure the front speaker panel by reinstalling all the remaining clips and T-30 hardware in the same locations removed during the disassembly process. Do not forget about reinstalling the additional hidden push pin under the driver's side dash, between the steering wheel and console, just forward of the tubular chassis support.
- 4** Reinstall the gauge panel with the two T-30 screws and two 10mm nuts. With this step completed, the driver side front speaker panel installation should be complete.
- 5** Follow the main harness from the bus bar and ensure the nuts on the connections are tight. Ensure the harnesses are secured to factory wiring with the included zip ties. Do not zip tie any part of the audio harness or the RCA audio cables to any heat or moisture sources, or to any moving parts.
- 6** Reinstall lower center console cover with two T-30 screws and two push pins. Refer to the top of page 6 for disassembly steps and simply do these in reverse.
- 7** Place the source unit's housing in the final center dash installation location with wiring neatly secured and zip tied in place. Attach the four included T-25 Torx screws through the housing's mounting holes into each of the four locations drilled out earlier. Two T-25 32mm screws in the front of the housing and the shorter two T-25 24mm screws in back.
- 8** Reinstall four T-30 screws in the center dash. Two forward of the gear selector and two additional in the upper center dash forward of the fuse panel. Once complete, reinstall the upper center dash access cover behind source unit housing. Refer to page 4 for disassembly steps and simply do these in reverse.
- 9** Reinstall driver and passenger center console side panels by gently snapping back into place. Ensure no wiring is exposed or pinched. Refer to page 4 for disassembly steps and simply do these in reverse.
- 10** Reinstall driver and passenger seats with the original 18mm bolts in the rear and 13mm bolts/nuts in the front. Refer to page 3 for disassembly steps and simply do these in reverse.

FINAL INSPECTION

Here is a check list to make sure your vehicle is ready to hit the trails. You should pull & tighten everything so that you know your Can-Am X3 and your audio equipment are secure.

- BATTERY IS FULLY CHARGED, ESPECIALLY AFTER TESTING AND FINE TUNING
- NEGATIVE BATTERY TERMINAL IS TIGHT AND SECURE
- NUTS WERE TIGHT ON HARNESS CONNECTION AT THE BUS BAR IN CENTER CONSOLE
- ALL POWER/SPEAKER HARNESSES IN CENTER CONSOLE ARE SECURED SO NOTHING IS LOOSE
- REAR SPEAKER PODS ARE TIGHTENED AND SECURE
- REAR SPEAKER WIRING IN ENGINE AND WHEEL WELL AREAS IS SECURED AND NEATLY TIED
- AMPLIFIERS MOUNTED AND ALL 7 NUTS WERE SECURED TO DUAL AMPLIFIER PLATE
- OPTIONAL 3rd AMPLIFIER MOUNTED ON ITS PLATE AND SECURED (IF USED)
- RIGHT FRONT SPEAKER PANEL FINAL MOUNTING FITS PROPERLY
- LEFT FRONT SPEAKER PANEL FINAL MOUNTING FITS PROPERLY
- ALL CENTER DASH AND CENTER CONSOLE PANELS ARE SECURED AND FITTED PROPERLY
- SUBWOOFER MOUNTS UNDER FRONT SEAT(S) ARE SECURE WITH SEATS REINSTALLED
- ALL SEATS MOVE PROPERLY FORWARD AND BACKWARD
- ENSURE NO LEFTOVER ORIGINAL HARDWARE - EVERY CLIP, SCREW & FASTENER IS IN PLACE
- ACCOUNT FOR ALL YOUR TOOLS SO NOTHING IS MISSING

COMPLETE WIRING LAYOUT

This is a complete wiring harness layout diagram, including optional equipment.

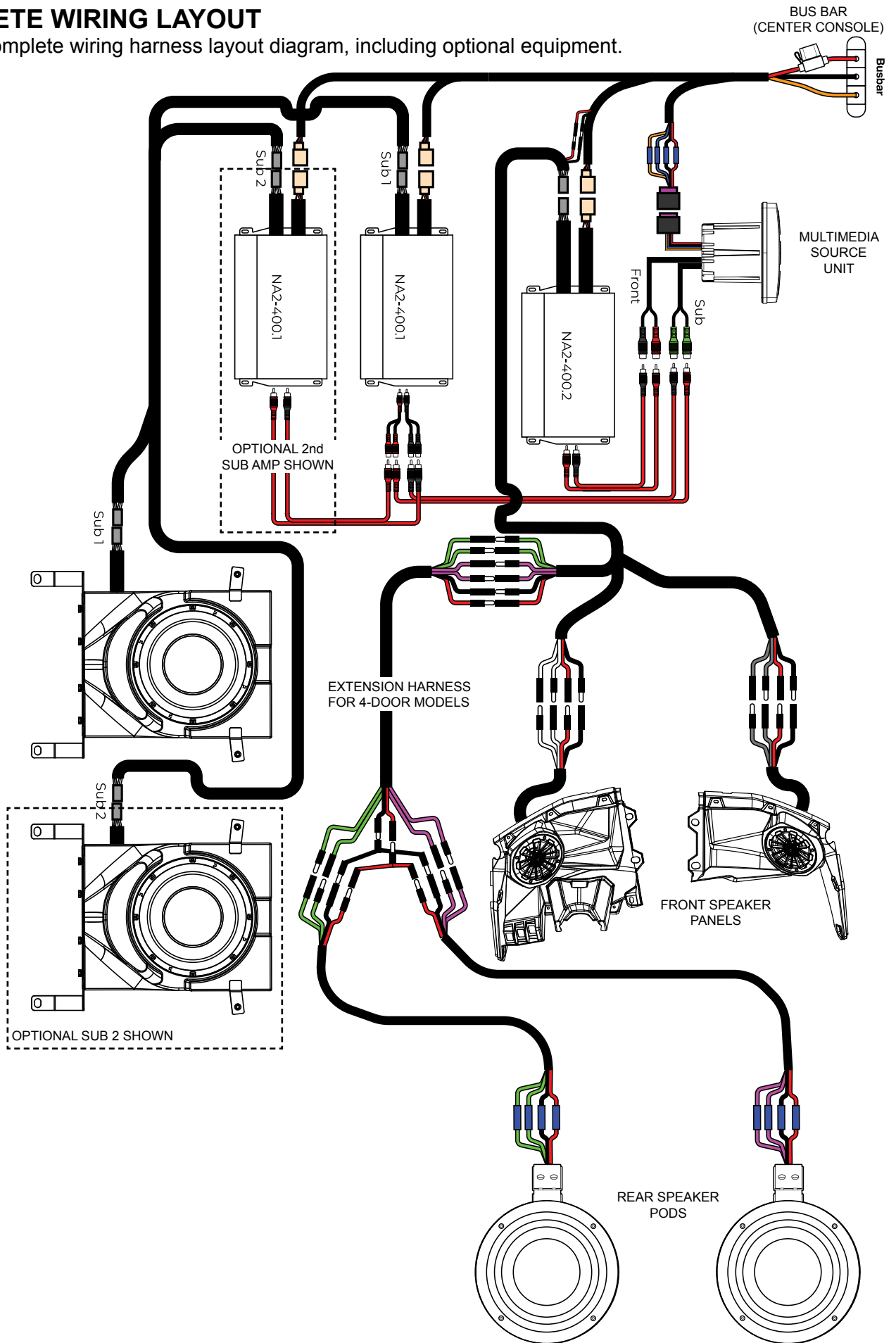



FCC Notice

This equipment has been tested and found to comply with the limits for a Class B digital device, pursuant to part 15 of the FCC Rules. These limits are designed to provide reasonable protection against harmful interference in a mobile installation. This equipment generates, uses and can radiate radio frequency energy and, if not installed and used in accordance with the instructions, may cause harmful interference to radio communications. However, there is no guarantee that interference will not occur in a particular installation.

WARNING: Changes or modifications not expressly approved by the party responsible for compliance could void the user's authority to operate the equipment.

This equipment complied with FCC radiation exposure limits set forth for an uncontrolled environment. This equipment should be installed and operated with minimum distance 20cm between the radiator & your body.

WARRANTY

Maxxsonics USA Inc. warrants this product, to the original consumer purchaser, to be free from defects in material and workmanship for a period of one (1) year from the date of purchase. Maxxsonics USA Inc. will, at its discretion, repair or replace defective products during the warranty period. Components that prove to be defective in materials and workmanship under proper installation and use must be returned to the original authorized Maxxsonics USA Inc. retailer from where it was purchased. A photocopy of the original receipt must accompany the product being returned. The costs associated with removal, re-installation and freight are not the responsibility of Maxxsonics USA Inc. This warranty is limited to defective parts and specifically excludes any incidental or consequential damages connected therewith. To view the full warranty, please visit the website.

The Bluetooth® word mark and logos are registered trademarks owned by the Bluetooth SIG, Inc. and any use such marks by MB Quart is under license.

All product names, logos, and brands are property of their respective owners. All company, product and service names used in this literature are for identification purposes only. Use of these names, logos, and brands does not imply endorsement.

©2020 Maxxsonics USA, Inc.

MBQuart products are designed and engineered in the USA by

